

# XS508B1PBL01M12

inductive sensor XS5 M8 - L33mm - stainless - Sn1.5mm - 12..24VDC - M12 - 0.15 m

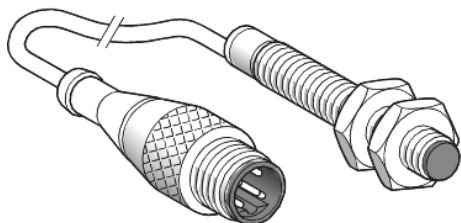

## Main

Range of product	Telemecanique Inductive proximity sensors XS
Series name	General purpose
Sensor type	Inductive proximity sensor
Device application	-
Sensor name	XS5
Sensor design	Cylindrical M8
Size	33 mm
Body type	Fixed
Detector flush mounting acceptance	Flush mountable
Material	Metal
Type of output signal	Discrete
Wiring technique	3-wire
[Sn] nominal sensing distance	1.5 mm
Discrete output function	1 NC
Output circuit type	DC
Discrete output type	PNP
Electrical connection	4 pins M12 remote male connector
Cable length	0.15 m
[Us] rated supply voltage	12...24 V DC with reverse polarity protection
Switching capacity in mA	<= 200 mA DC with overload and short-circuit protection
IP degree of protection	IP67 conforming to IEC 60529

## Complementary

Thread type	M8 x 1
Detection face	Frontal
Front material	PPS
Enclosure material	Nickel plated brass
Operating zone	0...1.2 mm
Differential travel	1...15% of Sr
Cable composition	3 x 0.11 mm <sup>2</sup>
Wire insulation material	PvR
Status LED	Output state: 1 LED (yellow)
Supply voltage limits	10...36 V DC
Switching frequency	<= 5000 Hz
Maximum voltage drop	<2 V (closed)
Current consumption	<= 10 mA no-load
Maximum delay first up	10 ms
Maximum delay response	0.1 ms
Maximum delay recovery	0.1 ms
Marking	CE
Threaded length	25 mm
Height	8 mm
Length	33 mm
Net weight	0.035 kg

## Environment

Product certifications	UL CSA
Ambient air temperature for operation	-25...70 °C
Ambient air temperature for storage	-40...85 °C
Vibration resistance	25 gn amplitude = +/- 2 mm (f = 10...55 Hz) conforming to IEC 60068-2-6
Shock resistance	50 gn for 11 ms conforming to IEC 60068-2-27

## Packing Units

Package 1 Weight	0.057 kg
Package 1 Height	0.420 dm
Package 1 width	0.970 dm
Package 1 Length	1.320 dm

## Contractual warranty

Warranty	18 months
----------	-----------

Dimensions

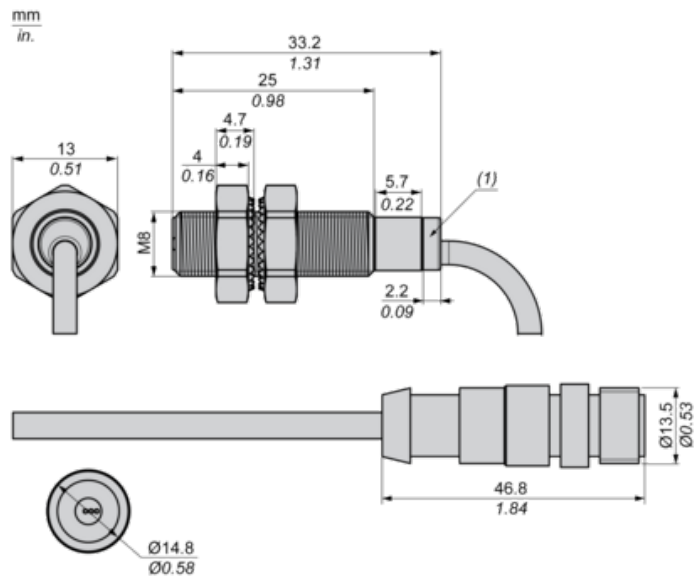

(1) LED

---

Minimum Mounting Distances

---

Side by side

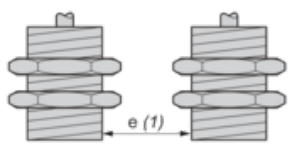

$e (1) \geq 3 \text{ mm}/0.12 \text{ in.}$

Face to face

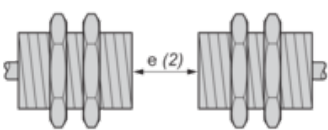

$e (2) \geq 18 \text{ mm}/0.71 \text{ in.}$

Facing a metal object

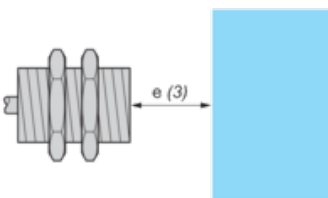

$e (3) \geq 4.5 \text{ mm}/0.18 \text{ in.}$

---

Wiring Schemes

---

M12 connector

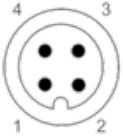

PNP

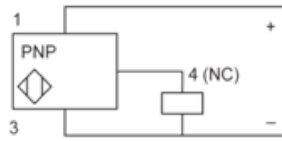

1 : (+)

2 : NC Output

3 : (-)

4 : Not connected

---

Performance Curves

---

Standard Steel Target : 8x8x1 mm

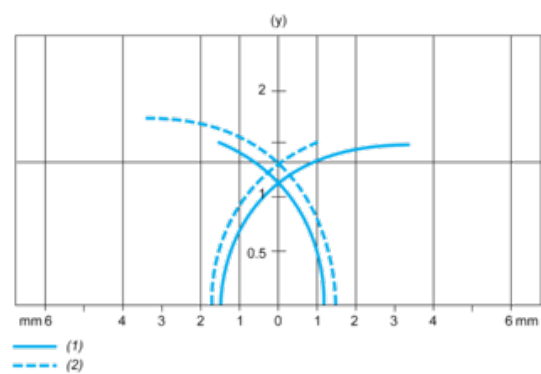

(1) Pick-up points

(2) Drop-out points (object approaching from the side)

(y) Sensing distance in mm